

YAN_

.mdd





DRIVE 4-7



YAN_Z 8-15

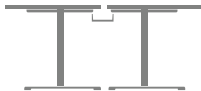

YAN_T 16-23



YAN_M 24-31



YAN_C 32-39



CONFERENCE TABLES 40-41



PANELS 42-47



CABLE MANAGEMENT 52-53

DRIVE

DRIVE bench gives the opportunity of quick and easy adjusting to individual needs without compromising on functionality and space. Each work counter has its own individual mechanism which works independently. DRIVE bench can be equipped with fabric panels to divide a work surface for more privacy. Dividing the work surface does not, in any way, reduce the access to the horizontal cable management underneath the work top.

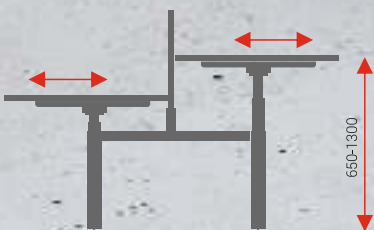

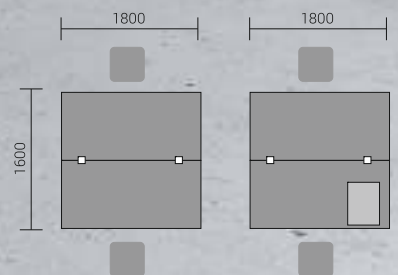

- CTA50** X 2 BENCH WITH ELECTRIC HEIGHT ADJUSTMENT SIT-STAND 1800/1690/660-1300
- ZD818** X 2 SONIC ACOUSTIC PANEL FOR BENCH DESK 1794/38/800
- A5504** STORAGE 801/432/1833
- A5404WZ** STORAGE WITH GLASS DOOR 801/432/1833
- A5104HZ** STORAGE WITH HPL FRONT 801/432/1833
- SLD13** X 2 PEDESTAL 402/600/586
- SAVA** X 2 CHAIR 660/610/1050-1150

DRIVE

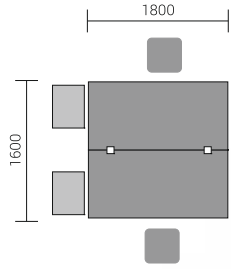

- CTA05** X 2 DESK WITH ELECTRICT HEIGHT ADJUSTMENT SIT-STAND 1800/800/650/1300
- ZPS618** SONIC ACOUSTIC PANEL FOR SINGLE DESK 1790/40/650
- ZN13** X 4 SONIC VERTICAL ACOUSTIC PANEL 800/40/650
- IKDT13** X 3 PEDESTAL 402/600/586
- A2L06** X 4 TAMBOUR STORAGE 1200/432/740
- S94** X 2 VERTICAL CABLE DUCTIN Ø140/750-1200
- SAVA** CHAIR 660/610/1050-1150

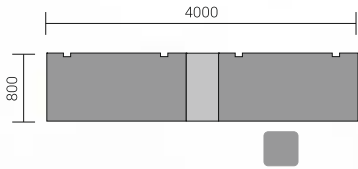

- CTA04** X 2 DESK WITH ELECTRICT HEIGHT ADJUSTMENT SIT-STAND 1600/800/650/1300
- ZPS616** X 2 SONIC ACOUSTIC PANEL FOR SINGLE DESK 1590/40/650
- S94** X 2 VERTICAL CABLE DUCTIN Ø140/750-1200
- KCD80P** CARGO PEDESTAL 402/800/1129
- IKDT12** PEDESTAL 402/600/586
- SAVA** CHAIR 660/610/1050-1150

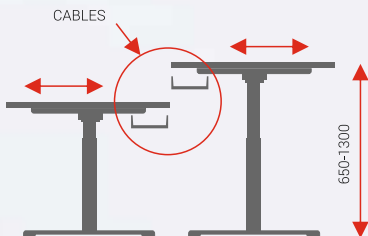



DRIVE is an electric height regulation desks which allows for customized standing and sitting positions and is a great ergonomically solution. The electrical height regulator, located underneath the work surface, simplifies changes in positions depending on one's office needs. Changing position during long working hours increases work effectiveness, productivity and health. To create an intimate climate, DRIVE allows you to add acoustic panels. There are two types of acoustic panels which fit perfectly both horizontally and vertically to the worktop.



YAN_Z



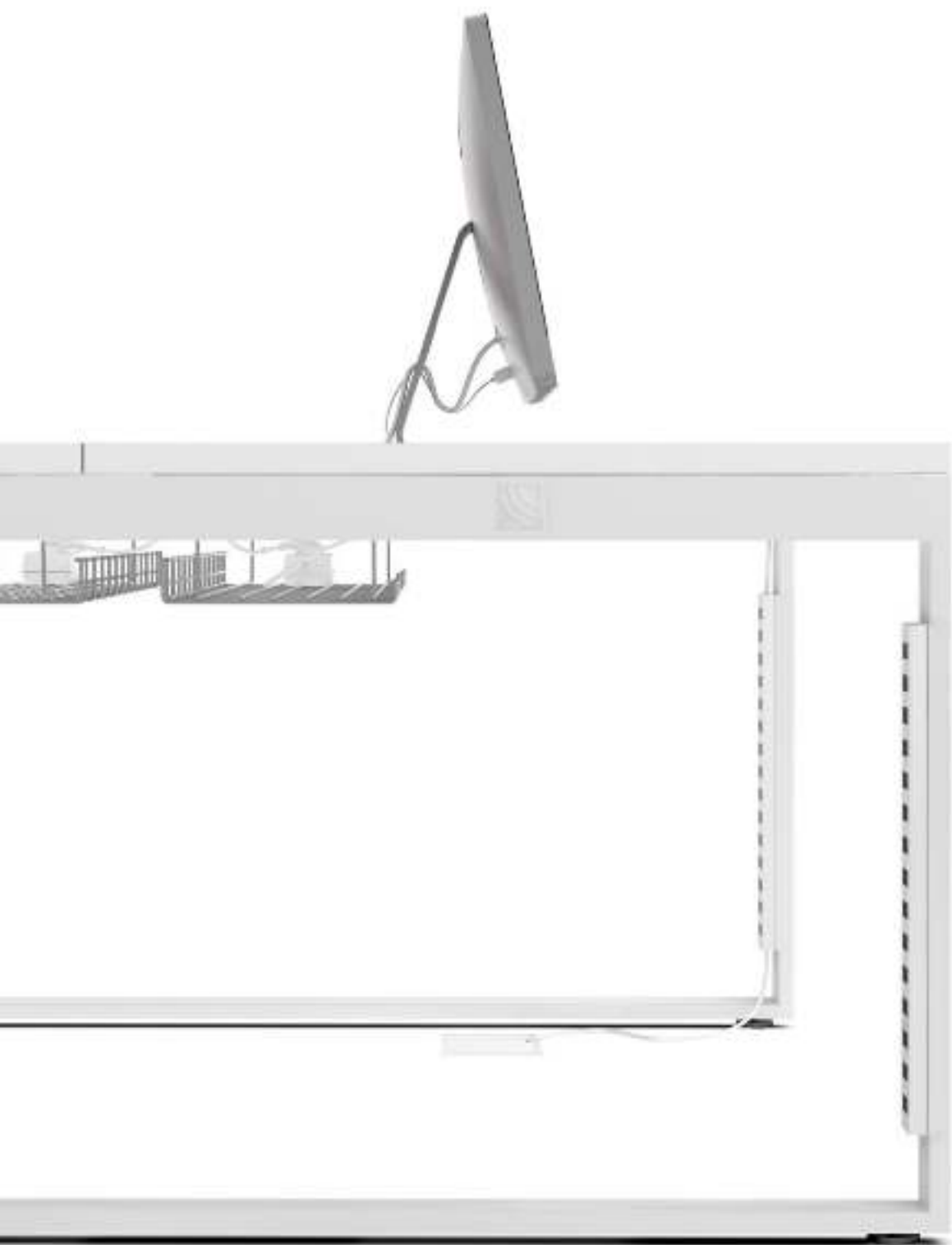

YAN_Z

YAN promotes interaction when employees spend time in teams and allows for privacy when needed. YAN meets office demands by improving performance and customer satisfaction. Thanks to its coherent attributes you can organize your office and reinvent a creative and functional space.



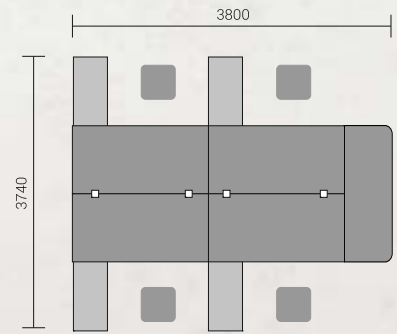

- ZBN05** X 2 DESK WITH MANAGERIAL SIDE STORAGE 1600/3740/740
- SKP13** X 4 PILLOW 416/600/40
- A3L08** X 2 TAMBOUR STORAGE 1200/432/1129
- SAVA** X 4 CHAIR 660/610/1050-1150
- CAN11** X 2 CANOE LAMP 1105/360/360
- PL180** EXTENSION 1600/600/28

YAN_Z

Side desk storages for both single desks and benches act as a construction element reducing the need for an additional leg thus maximizing the space underneath the desk. Wide variety of storage solutions allows for a tailor-made office interior.

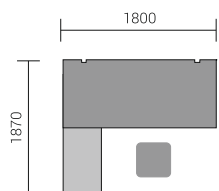

ZBN03 DESK WITH MANAGERIAL SIDE STORAGE 1800/1870/740

UN16 MFC MODESTY PANEL 1600/18/400

SAVA CHAIR 660/610/1050-1150

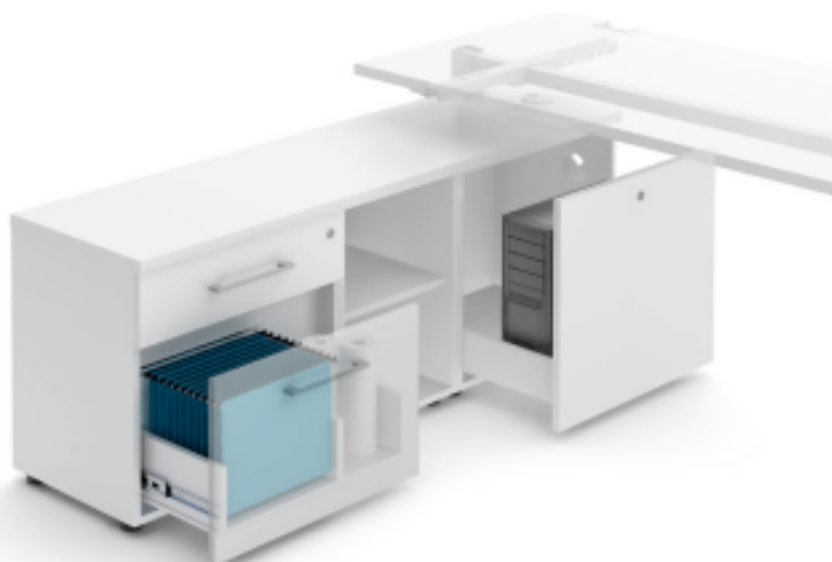



- ZBN16L** ELEMENTS FOR DESK PAIRING 1600/1600/740
- BZB16** DOUBLE DESK TOP 1600/1600/83
- S160** X 4 METAL CABLE TRAY 1116/244/98
- S93** X 2 VERTICAL HITCH 470/62/34
- ZUT26** X 2 TWIN FABRIC PANEL 1590/30/450
- SAVA** X 4 CHAIR 660/610/1050-1150
- KRT74LP** X 2 PEDESTAL 402/800/740
- KRT74L** PEDESTAL 402/800/740
- KRT74P** PEDESTAL 402/800/740

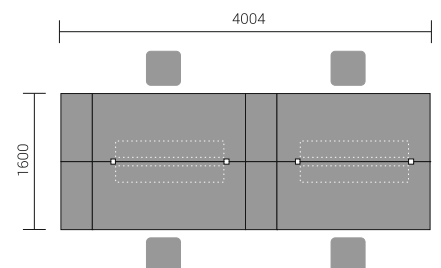

YAN is a simple yet multi-functional system which blends well into an office space arrangement. Its flexibility allows for a quick response to different office work requirements. Sliding desk tops give easy access to cable management. Distinctive panel designs enable to build an office of a particular character.

YAN_Z

YAN has been designed to offer the possibility of combining different components into a multi functional office layout. Tambour or sliding door storages, high or desk level can be used as an end element. Different height and functionality pedestals may act as both dividing or finishing section; individual or team storage.



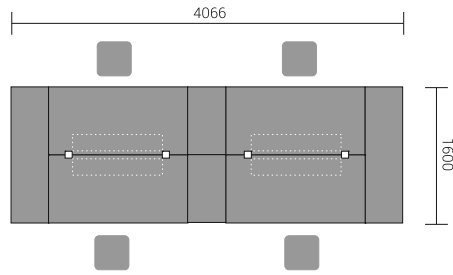

- BZB14** X 2 DOUBLE DESK TOP 1400/1600/83
- BA2L08** X 2 TAMBOUR STORAGE 1600/432/740
- S140** X 4 METAL CABLE TRAY 916/244/98
- ZUT34** X 2 TWIN FABRIC PANEL 1390/30/360
- SAVA** X 4 CHAIR 660/610/1050-1150

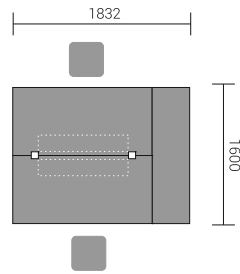

- ZBN14L** ELEMENT FOR DESK PAIRING 1400/1600/740
- BA2L08** TAMBOUR STORAGE 1600/432/740
- S140** X 2 CABLE TRAY 916/244/98
- ZUT34** TWIN FABRIC PANEL 1390/30/360
- ZS01** SLIDING DOOR STORAGE 2000/434/1129
- SAVA** X 2 CHAIR 660/610/1050-1150



EXAMPLES OF STORAGE ARRANGEMENTS



YAN_T





YAN_T

Simple and flexible, YAN's construction is practical for your desired space or can be conveniently changed on the go to reflect the needs of your office. Whatever the type of workplace, YAN blends well in a different office situations.



- BRN06** X 2 DESK 1600/800/740
- S93** X 4 VERTICAL HITCH 470/62/34
- S87** X 2 CPU HOLDER 212/460/600
- IKRT13** X 2 PEDESTAL 402/600/586
- IA3104** X 3 STORAGE 801/432/1129
- ZW818** X 2 SONIC FREE STANDING PANEL 800/38/1800
- SAVA** X 2 CHAIR 660/610/1050-1150

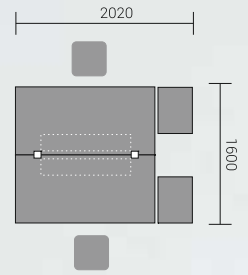

YAN_T

YAN managerial storage was designed to optimize and organize the work space. It is a construction element of the desks eliminating the need for additional leg. Thought through storage interior allows to hide a computer box as well as suspension files and personal belongings.

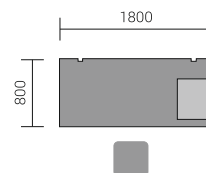

BRN08 DESK 1800/800/740
IKRT13 PEDESTAL 402/600/586
ZS01 MANAGERIAL STORAGE 2000/434/1129
SAVA CHAIR 660/610/1050-1150



EXAMPLES OF STORAGE ARRANGEMENTS



YAN sliding tops give access to horizontal cable management.
Desk's construction offers an extraordinary ergonomic qualities
with a large working area and all necessary advises and items within an easy reach.



YAN_T

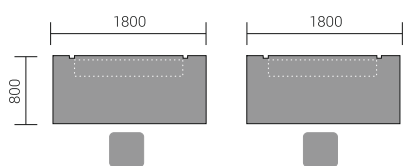

BRN08R X 2 DESK WITH MANUAL HEIGHT ADJUSTMENT 1800/800/640-840

S180 X 2 METAL CABLE TRAY 1316/244/98

S94 VERTICAL CABLE DUCTING Ø140/750

A3504 STORAGE 801/432/1129

A3104HZ X 2 STORAGE WITH HPL FRONT 801/432/1129

SAVA X 2 CHAIR 660/610/1050-1150



YAN not only serves your present day basic needs but provides an answer to growing demands of the future office. YAN offers desks with manual height regulation. When the need arises you can comfortably set and regulate the height to your liking and situation.





YAN_M





YAN_M

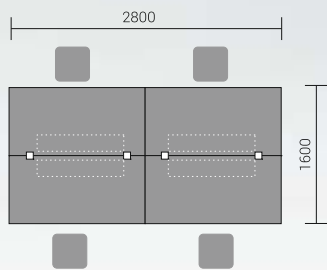

- BLN14** BENCH DESK 1400/1600/740
- BLN14L** ELEMENT FOR DESK PAIRING 1400/1600/740
- S140** X 4 METAL CABLE TRAY 916/244/98
- S93** VERTICAL HITCH 470/62/34
- ZUS14** X 2 SONIC ACOUSTIC PANEL 1390/40/350
- ZYS78** SONIC VERTICAL ACOUSTIC PANEL FOR BENCH DESKS 2X 800/30/350
- A6505** X 8 STORAGE 1000/432/2185
- A14M** X 2 MANAGER STORAGE 1400/432/600
- SAVA** X 4 CHAIR 660/610/1050-1150



YAN is the ultimate solution for companies that have multiple project teams who need more room to work and positively interact. YAN was developed in such a way that essential ideas can be exchanged. This is why you can use the panels interchangeably by dividing your workplace into straight or intersecting sections. In our offer, you can find five different types of panels which differentiate themselves by shape, finish and color.

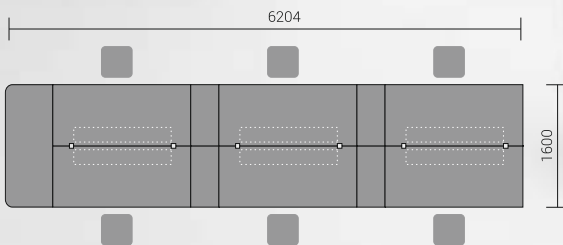

- BLN16L** X 2 ELEMENT FOR DESK PAIRING 1600/1600/83
- BZB16** DOUBLE DESK TOP 1600/1600/83
- PL180** EXTENSION 1600/600/28
- S160** X 6 METAL CABLE TRAY 1116/244/98
- S93** X 4 VERTICAL HITCH 470/62/34
- KCD80SP** X 4 CARGO PEDESTAL 402/800/1129
- ZUT36** X 3 TWIN FABRIC PANEL FOR BENCH DESKS 1590/30/560
- SAVA** X 6 CHAIR 660/610/1050-1150

One of the most important elements in planning your ergonomic office space, is the functionality of your office furniture. YAN system offers a solution for creating workstations using Cargo containers. Cargo fulfills its role not only as a construction element but also as a place to rearrange all of your crucial documents. This type of arrangement is important in achieving optimal performance.



- BLN06L** ELEMENT FOR DESK PAIRING 1600/800/740
- S160** METAL CABLE TRAY 1116/244/98
- S87** CPU HOLDER 212/460/660
- KCD80P** CARGO PETESTAL 402/800/1129
- SAVA** CHAIR 660/610/1050-1150

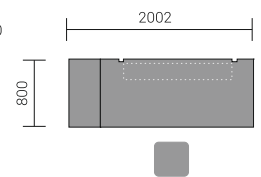

EXAMPLES OF CARGO STORAGE ARRANGEMENTS



YAN_M

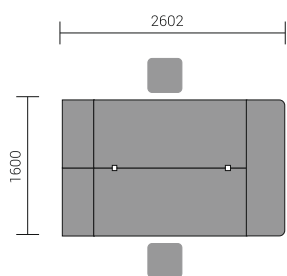

- BLN16L** ELEMENT FOR DESK PAIRING 1600/1600/740
- KRT73P** PEDESTAL 402/800/740
- KRT73L** PEDESTAL 402/800/740
- PL180** EXTENSION 1600/600/28
- ZUS16** SONIC ACOUSTIC PANEL 1590/38/350
- SAVA** X 2 CHAIR 660/610/1050-1150



The main attribute of the YAN system is the possibility of easy configuring individual desks and benches in a number of ways.

Desk tops can be supported by metal legs, which come in four shapes to choose from, or different storage solutions.

By enlarging the work area with extending elements, a space for greater interaction can be easily build.

- BZB14** DOUBLE DESK TOP 1400/1600/28
- BA2P08** X 2 SLIDING DOOR STORAGE 1600/432/740
- S140** X 2 METAL CABLE TRAY 916/244/98
- SAVA** X 2 CHAIR 660/610/1050-1150

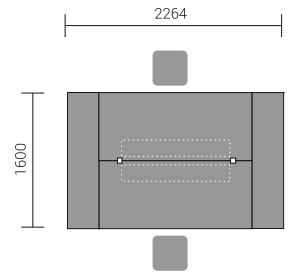

YAN_C



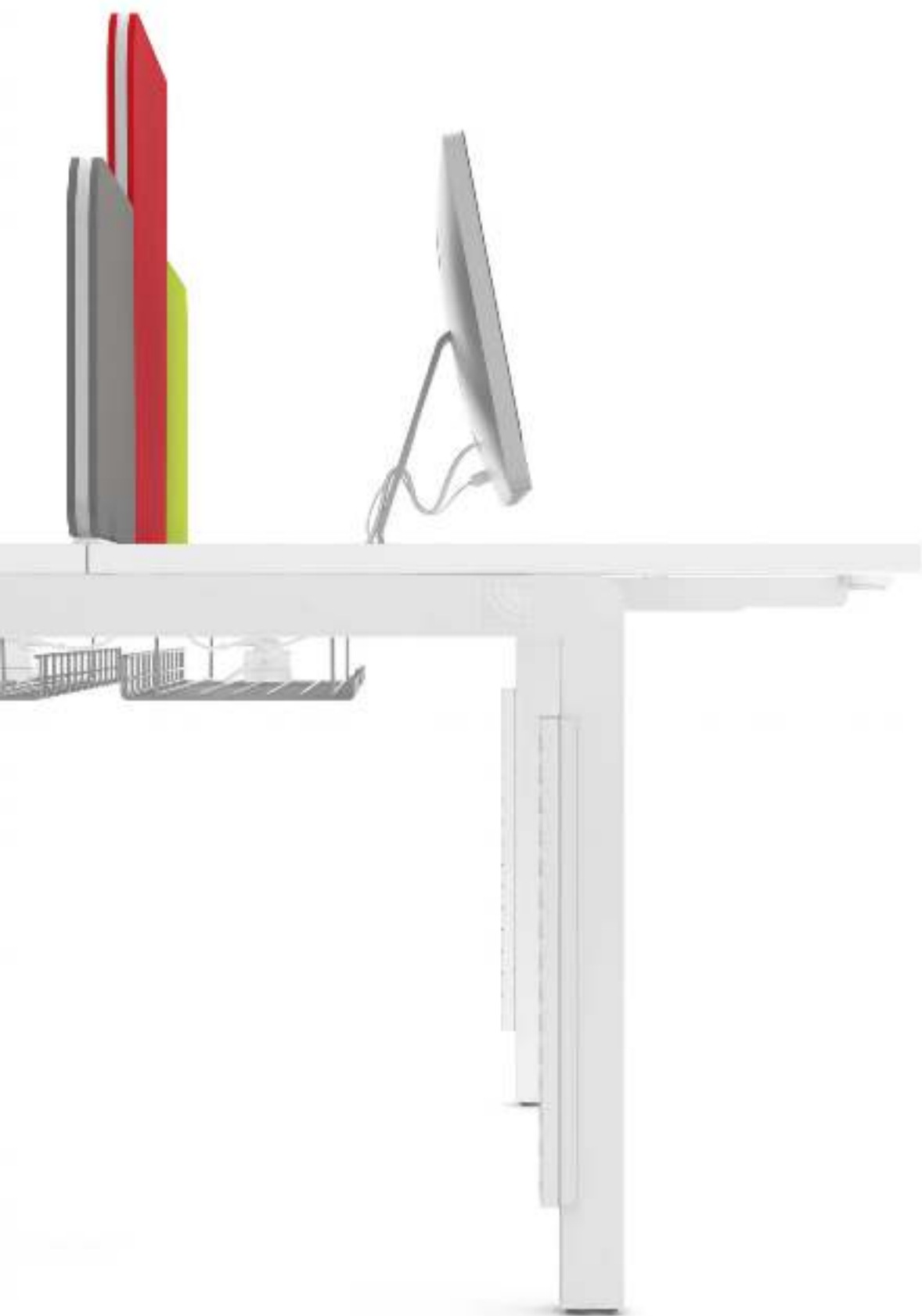

YAN_C

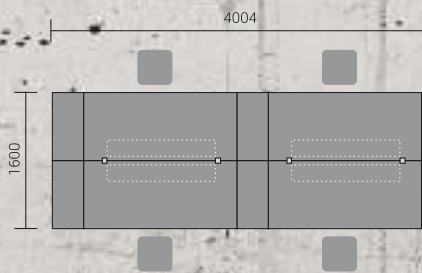

- BUN16L** ELEMENT FOR DESK PAIRING 1600/1600/740
- BZB16** DOUBLE DESK TOP 1600/1600/28
- KRT74LP** X 2 PEDESTAL 402/800/740
- KRT74L** PEDESTAL 402/800/740
- KRT74P** PEDESTAL 402/800/740
- S160** X 4 METAL VERTICAL TRAY 1116/244/98
- S93** X 2 VERTICAL HITCH 470/62/34
- ZUT36** X 2 TWIN FABRIC PANEL FOR BENCH DESKS 1590/30/560
- A3104HZ** X 3 STORAGE WITH HPL FRONT 801/432/1129
- SAVA** X 4 CHAIR 660/610/1050-1150



YAN can be personalized to an individual office needs. An accessible array of colors and materials helps to add character to the whole office or to a selected area. Arranging an office with different panels add distinctive style to the office space design.



YAN_C

YAN promotes simplicity combined with a great variety and choice. Apart from many different styled panels, legs and storages there are different solutions for cable management. Combine vertical and horizontal cable organizer options to create a hassle free workspace environment. Each solution is universal for different YAN styles.

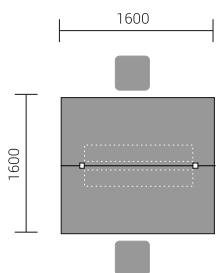

- BUN16** BENCH DESK 1600/1600/740
- S160** X 2 METAL CABLE TRAY 1116/244/98
- S93** X 2 VERTICAL HITCH 470/62/34
- ZUS16** SONIC ACOUSTIC PANEL 1590/38/350





YAN_C

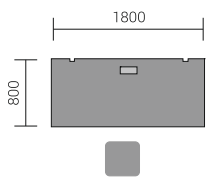

- BUN22R** DESK WITH MANUAL HEIGHT ADJUSTMENT 1800/800/740
- M04** MEDIABOX 4X230V; 2XRJ45; 1XUSB
- UM16** MFC MODESTY PANEL 1600/18/400
- ZS01** SLIDING DOOR STORAGE 2000/432/1129
- CAN11** CANOE LAMP 1105/360/360
- SAVA** CHAIR 660/610/1050-1150



YAN represents a line of office furniture which can be very individual and personal and at the same time have the integrating factor with the rest of the office space. YAN has been designed to not only serve multi-station offices, but also for creating professional spaces for managers and directors. Combined with side tables, and partition walls a complete and cozy work environment can be created.

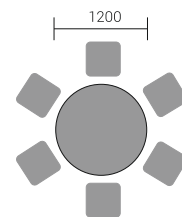

ST12 TABLE Ø1200/730
ZW818 X 3 FREE STANDING PANEL
GAYA X 5 CHAIR 660/510/825



YAN_CONFERENCE

In every company there is a need for a meeting space where business dialogue can be conducted. YAN offers a wide range of conference and meeting tables covering different styles to blend in with the rest of the office design.



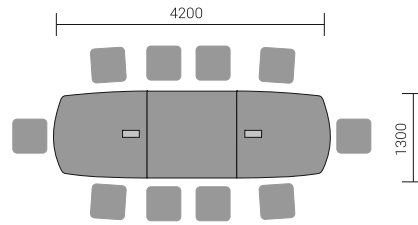

- BUN24S** MEETING TABLE 1300/1400/740
- BUN24L** MEETING TABLE 1300/1400/740
- M04** MEDIABOX 4X230V; 2XRJ45; 1XUSB
- BUN24P** MEETING TABLE 1300/1400/740
- M04** MEDIABOX 4X230V; 2XRJ45; 1XUSB
- IA3P06** X 2 SLIDING DOOR STORAGE 1200/432/1129
- HPR2** X 2 HANDLES PRO 160/110/20
- SNL16** SUNBEAN LAMP Ø1440/410
- GAYA** X 8 CHAIR 660/510/825



YAN_PANELS

YAN panels present different styles to suit individual needs. Functionality of panels together with the diversity of design and characteristic patterns give you customized work area in a new look.



1190-1790 mm

SONIC ACOUSTIC PANELS



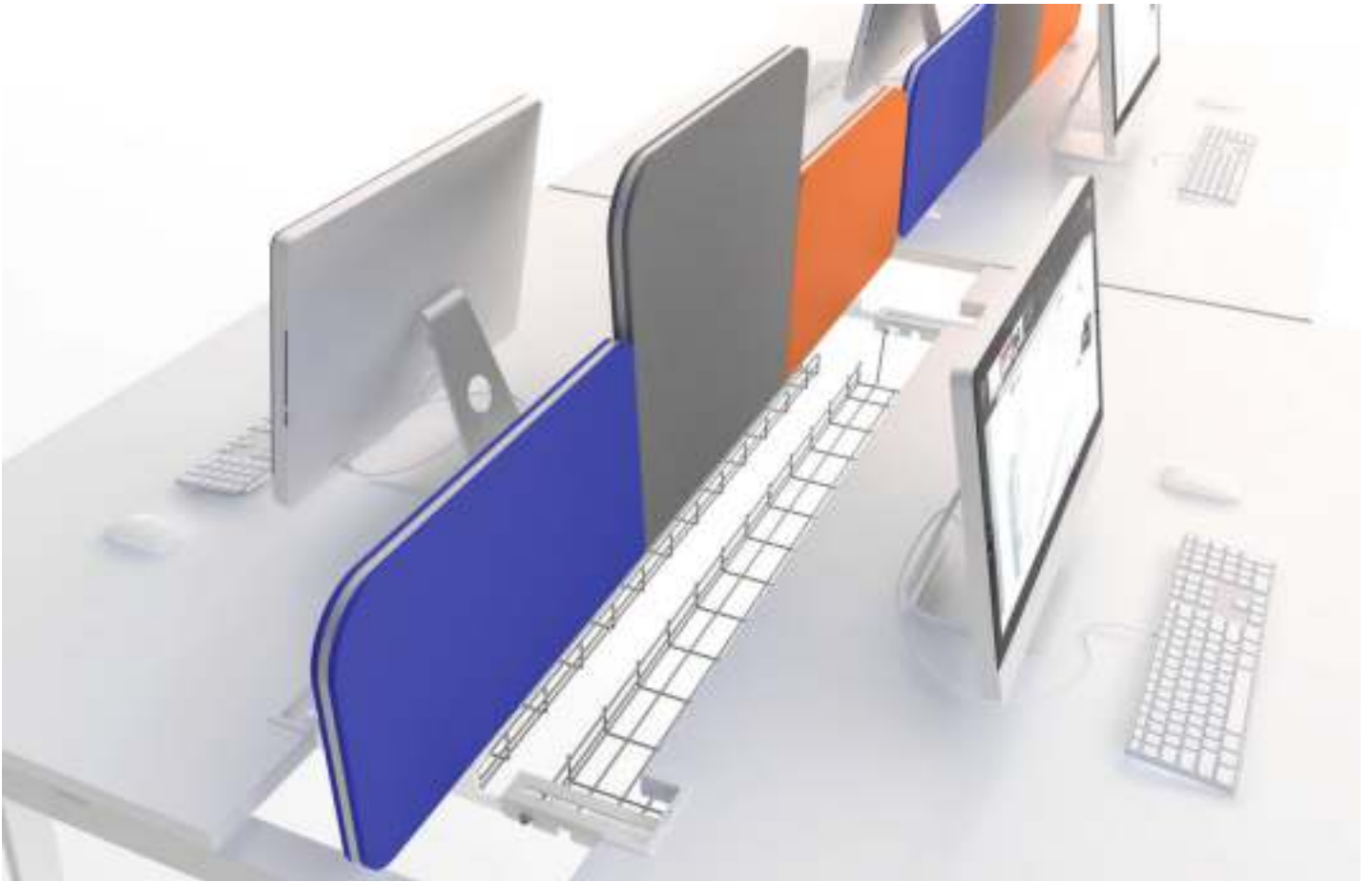

TWIN PANELS FOR BENCH DESKS



1590-1790 mm



1590-1790 mm



1190-1390 mm

Open workspaces do not have to be boring. Vibrant colors and diverse forms of panels, break up the static nature of the system, promoting creative inventiveness.



TWIN VERTICAL FABRIC PANELS FOR BENCH DESKS

YAN_PANELS

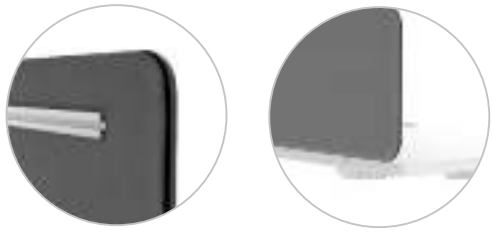

SONIC PANELS h350mm, h500 mm

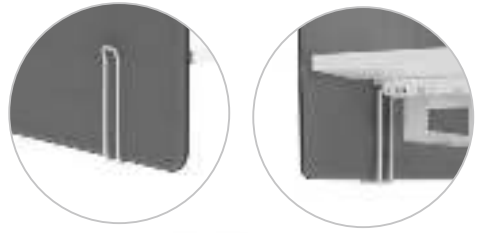

SONIC PANELS h650mm, h800 mm



VIVA FREE STANDING SCREENS h1670 mm

Simple and elegant partition walls can act both as regular panels, dividing work stations into individual sections or as standard partition walls dividing open space depending on the needs.

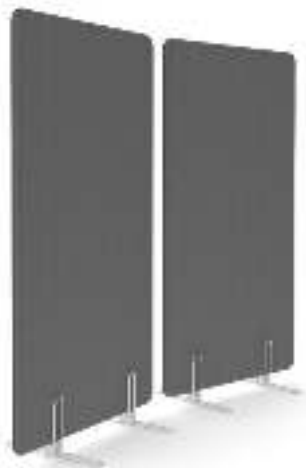

SONIC FREE STANDING SCREENS h1250mm, h1850 mm

YAN_PANELS



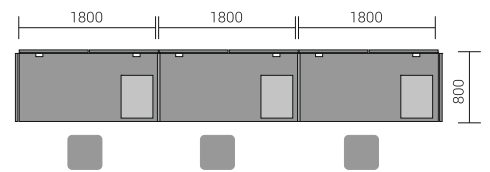

- BRN08** X 3 DESK 1800/800/740
- ZUS50** X 4 SONIC ACOUSTIC SIDE PANEL FOR SINGLE DESK 800/40/800
- ZPS818** X 3 SONIC ACOUSTIC PANEL FOR SINGLE DESK 1790/40/800
- IKRT13** X 3 PEDESTAL 402/600/586
- S87** X 3 CPU HOLDER 212/460/600
- SAVA** X 3 CHAIR 660/610/1050-1150

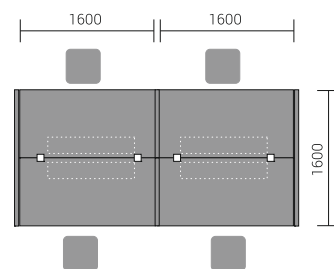

- ZBN16** BENCH DESK 1600/1600/740
- ZBN16L** ELEMENT FOR DESK PAIRING 1600/1600/740
- ZUS16** X 2 SONIC ACOUSTIC PANEL 1590/40/350
- ZYS78** SONIC VERTICAL ACOUSTIC PANEL FOR BENCH DESK 1600/30/350
- ZUS31** X 2 SONIC ACOUSTIC SIDE PANEL FOR BENCH 1600/40/650
- SAVA** X 3 CHAIR 660/610/1050-1150

YAN_ELEMENTS

YAN presents a large variety of ways in which a desk top can be supported. These include four different shapes of legs, and several storage options. It allows for creating simple yet functional work areas.

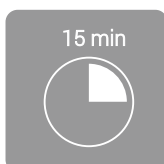
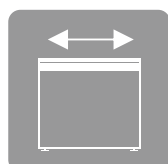
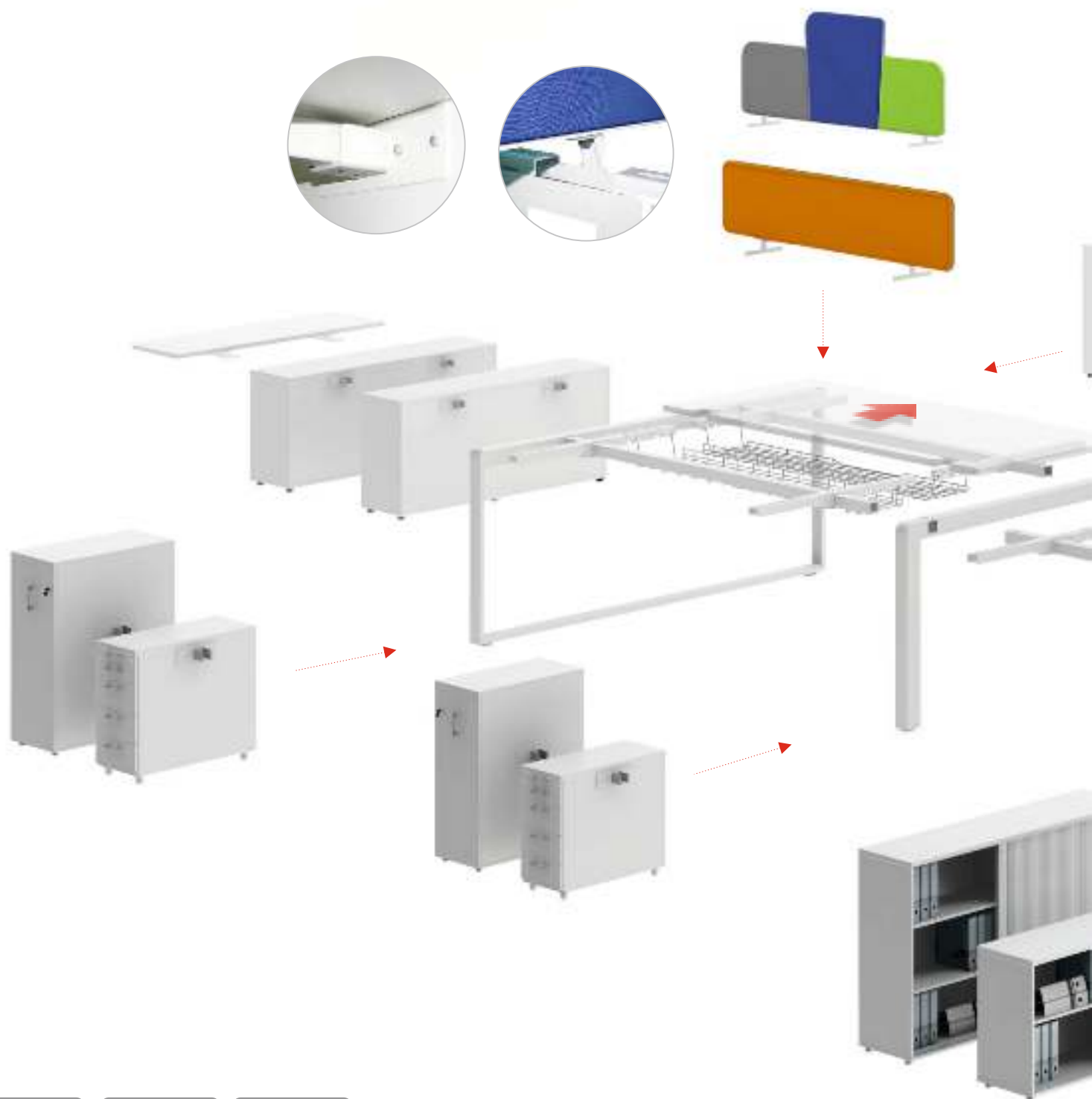

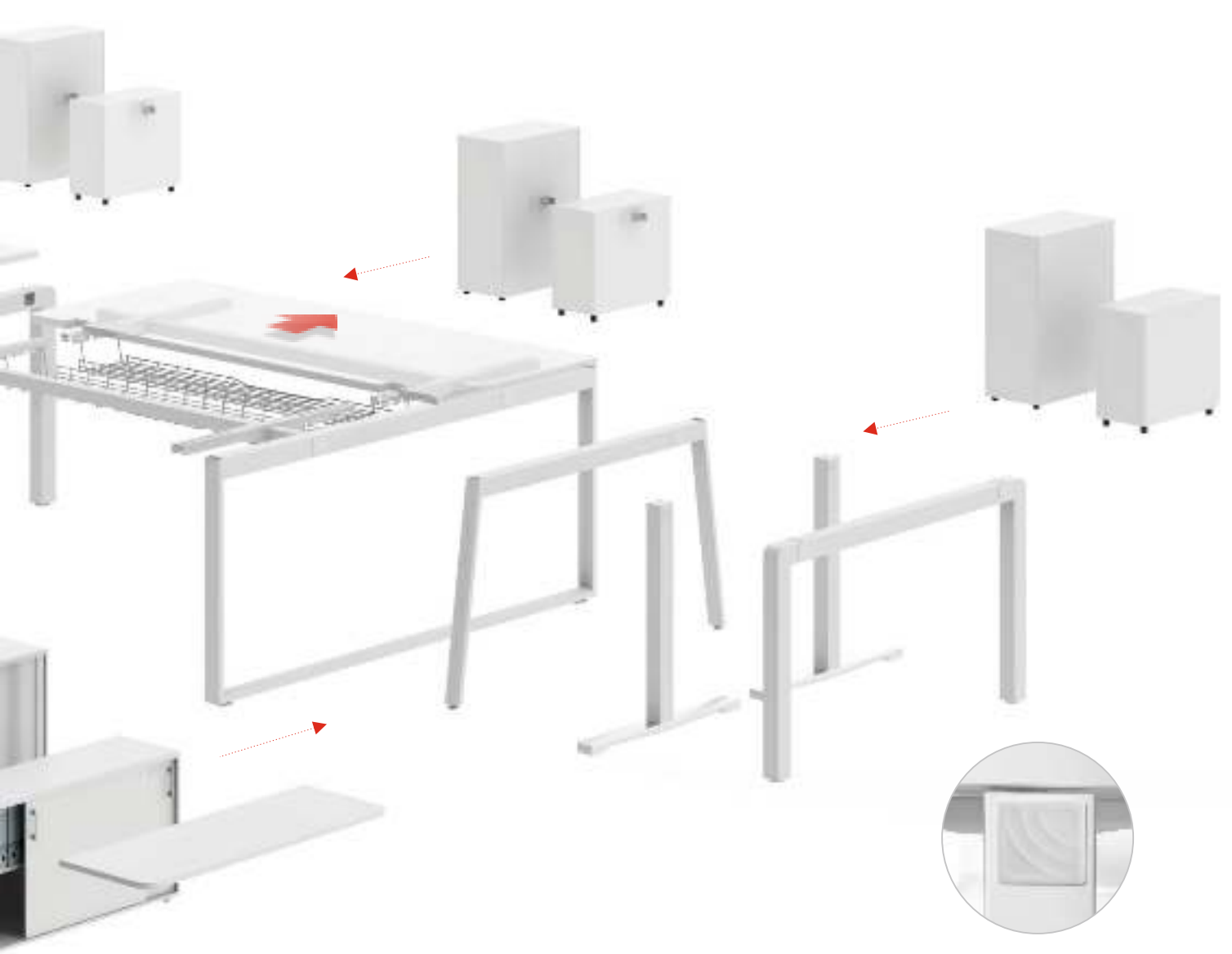
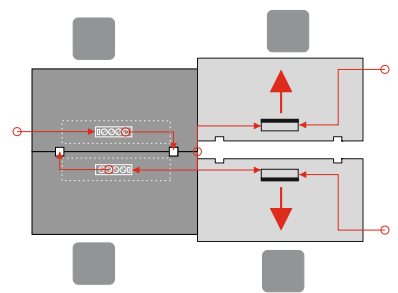
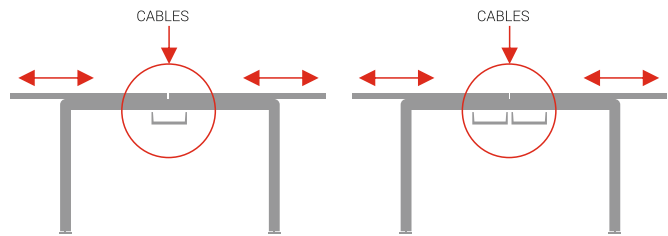

YAN_ELEMENTS

- QUICK AND EASY ASSEMBLY SYSTEM
- SLIDING DESK TOPS: DIRECT AND EASY CABLE MANAGEMENT ACCESS
- VERSATILE AND SMART
- HEIGHT ADJUSTABLE: MANUAL AND ELECTRIC OPTIONS



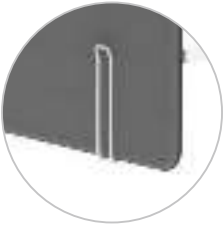
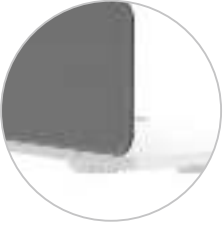
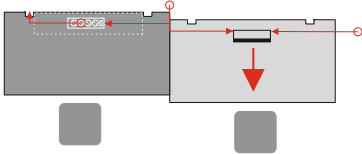
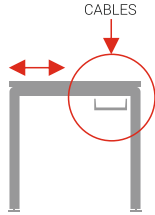
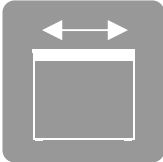

CABLE MANAGEMENT



VERTICAL CABLE HITCH S93
CPU HOLDER S83



VERTICAL CABLE DUCTING S94 FOR HEIGHT
ADJUSTABLE DESKS



VERTICAL CABLE DUCTING S81
TOP ACCESS M05



MEDIABOX M04:
2XRJ45, 1XUSB, 4X230V

M04 - the product has been developed with several solutions to guarantee an easy, in-built arrangement of all wires required for electricity, telephone and data transfer



HORIZONTAL CABLE TRAY

- DIFFERENT LENGTHS
- UNIVERSAL FOR INDIVIDUAL DESK OR BENCH SOLUTIONS

CHESTNUT



CANADIAN OAK



POLAR BIRCH



WHITE PASTEL

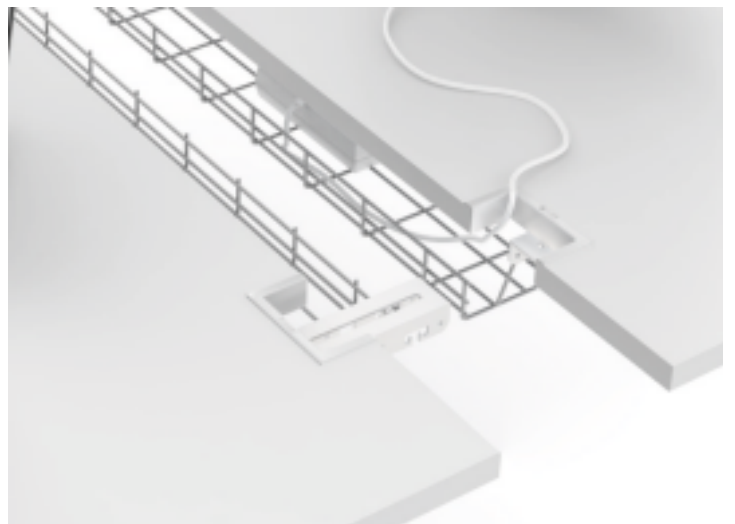

GROMMETS AND PRESS BUTTONS
- DIFFERENT COLOURS

YAN_M

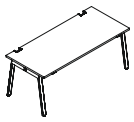

BLN02 1200-800-740
BLN04 1400-800-740
BLN06 1600-800-740
BLN08 1800-800-740

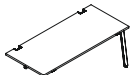

BLN02L 1200-800-740
BLN04L 1400-800-740
BLN06L 1600-800-740
BLN08L 1800-800-740

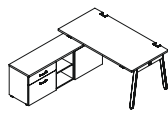

BLN01 1600-1870-740
BLN03 1800-1870-740

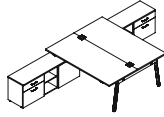

BLN05 1600-3740-740
BLN07 1800-3740-740



BLN12 1200-1600-740
BLN14 1400-1600-740
BLN16 1600-1600-740
BLN18 1800-1600-740



BLN12L 1200-1600-740
BLN14L 1400-1600-740
BLN16L 1600-1600-740
BLN18L 1800-1600-740



PL180 1600-600-28

YAN_Z

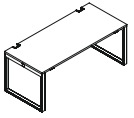

ZBN02 1200-800-740
ZBN04 1400-800-740
ZBN06 1600-800-740
ZBN08 1800-800-740

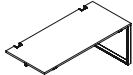

ZBN02L 1200-800-740
ZBN04L 1400-800-740
ZBN06L 1600-800-740
ZBN08L 1800-800-740

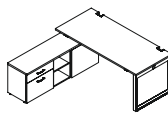

ZBN01 1600-1870-740
ZBN03 1800-1870-740

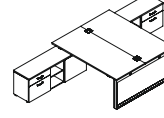

ZBN05 1600-3740-740
ZBN07 1800-3740-740

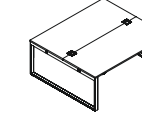

ZBN12 1200-1600-740
ZBN14 1400-1600-740
ZBN16 1600-1600-740
ZBN18 1800-1600-740

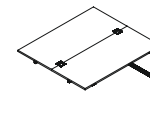

ZBN12L 1200-1600-740
ZBN14L 1400-1600-740
ZBN16L 1600-1600-740
ZBN18L 1800-1600-740



PL180 1600-600-28

YAN_T

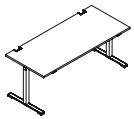

BRN02 1200-800-740
BRN04 1400-800-740
BRN06 1600-800-740
BRN08 1800-800-740

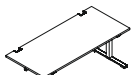

BRN02L 1200-800-740
BRN04L 1400-800-740
BRN06L 1600-800-740
BRN08L 1800-800-740

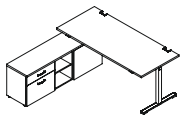

BRN01 1600-1870-740
BRN03 1800-1870-740

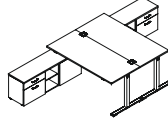

BRN05 1600-3740-740
BRN07 1800-3740-740

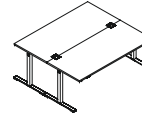

BRN12 1200-1600-740
BRN14 1400-1600-740
BRN16 1600-1600-740
BRN18 1800-1600-740

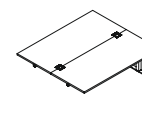

BRN12L 1200-1600-740
BRN14L 1400-1600-740
BRN16L 1600-1600-740
BRN18L 1800-1600-740

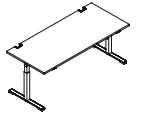

BRN02R 1200-800-640/840
BRN04R 1400-800-640/840
BRN06R 1600-800-640/840
BRN08R 1800-800-640/840

YAN_C

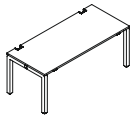

BUN19 1200-800-740
BUN20 1400-800-740
BUN21 1600-800-740
BUN22 1800-800-740

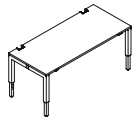

BUN19R 1200-800-640/840
BUN20R 1400-800-640/840
BUN21R 1600-800-640/840
BUN22R 1800-800-640/840



BUN02L 1200-800-740
BUN04L 1400-800-740
BUN06L 1600-800-740
BUN08L 1800-800-740

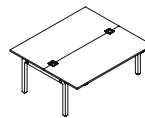

BUN12 1200-1600-740
BUN14 1400-1600-740
BUN16 1600-1600-740
BUN18 1800-1600-740

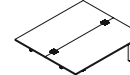

BUN12L 1200-1600-740
BUN14L 1400-1600-740
BUN16L 1600-1600-740
BUN18L 1800-1600-740



PL180 1600-600-28

PEDESTALS

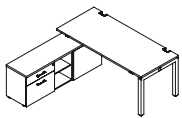

BUN01 1600-1870-740
BUN03 1800-1870-740

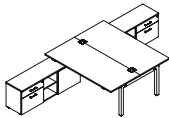

BUN05 1600-3740-740
BUN07 1800-3740-740

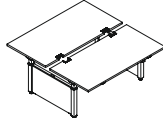

CTA20 1200-1690-650/1300
CTA30 1400-1690-650/1300
CTA40 1600-1690-650/1300
CTA50 1800-1690-650/1300

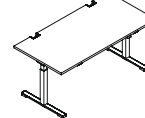

CTA02 1200-800-650/1300
CTA03 1400-800-650/1300
CTA04 1600-800-650/1300
CTA05 1800-800-650/1300



ZD812 1196-40-800
ZD814 1396-40-800
ZD816 1596-40-800
ZD818 1794-40-800



ZN13 800-40-650

PEDESTALS



IKRT12 402-600-586



IKRT13 402-600-586



IKRT63 402-600-740



IKRT64 402-600-740



IKDT12 402-600-586



IKDT13 402-600-586



IKDT63 402-600-740



IKDT64 402-600-740

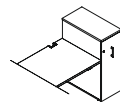

KCD80P 402-800-1129

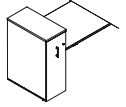

KCD80L 402-800-1129

STORAGES

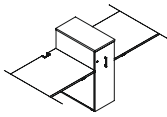

KCD80SL 402-800-1129

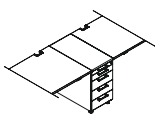

KRT74P 402-800-740
KRT74LP 402-800-740
KRT74L 402-800-740

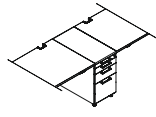

KRT73P 402-800-740
KRT73LP 402-800-740
KRT73L 402-800-740

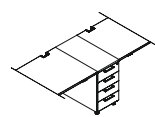

KDT74P 402-800-740
KDT74LP 402-800-740
KDT74L 402-800-740

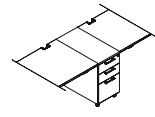

KDT73P 402-800-740
KDT73LP 402-800-740
KDT73L 402-800-740

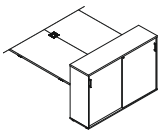

BA3P08 1600-432-1129

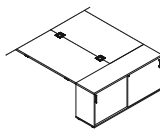

BA2P08 1600-432-740

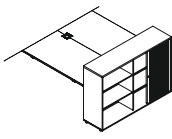

BA3L08 1600-432-1129

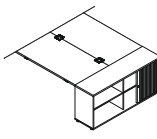

BA2L08 1600-432-740

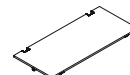

BZB02 1200-800-83
BZB04 1400-800-83
BZB06 1600-800-83
BZB08 1800-800-83

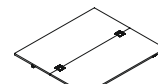

BZB12 1200-1600-83
BZB14 1400-1600-83
BZB16 1600-1600-83
BZB18 1800-1600-83

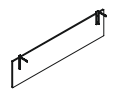

UM10 1000-18-400
UM12 1200-18-400
UM14 1400-18-400
UM16 1600-18-400

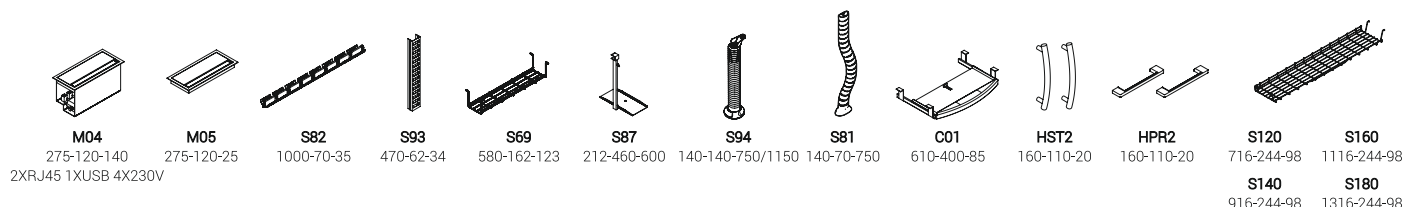
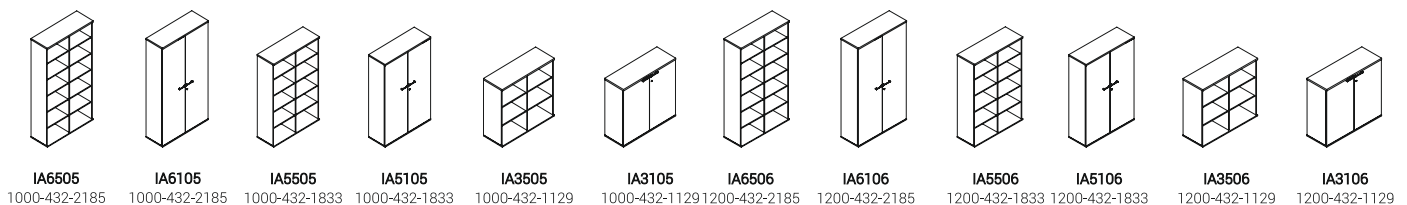
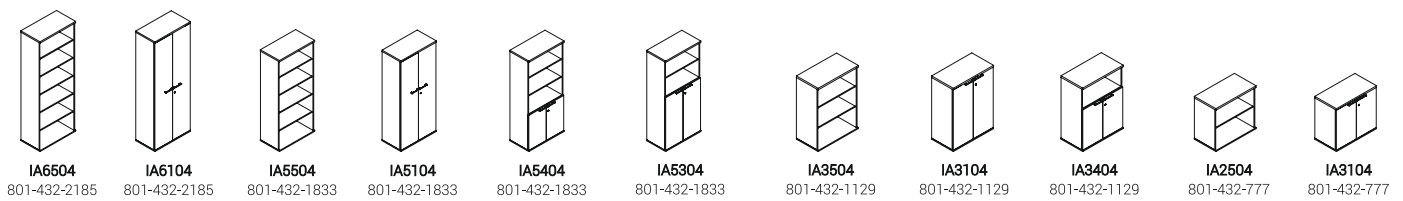
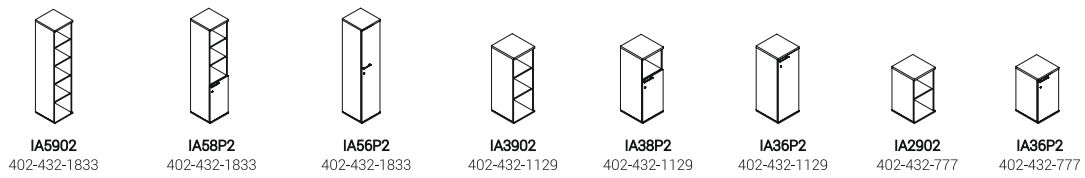
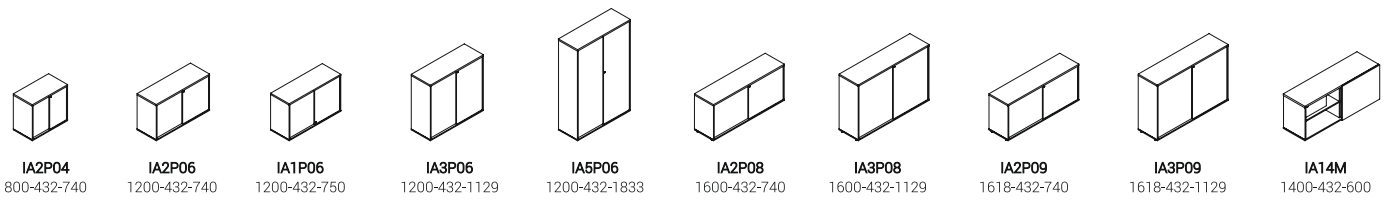
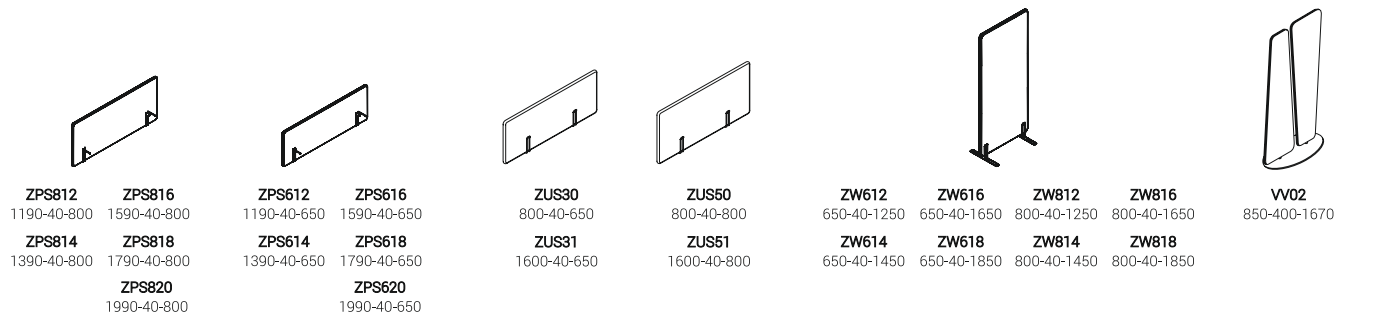
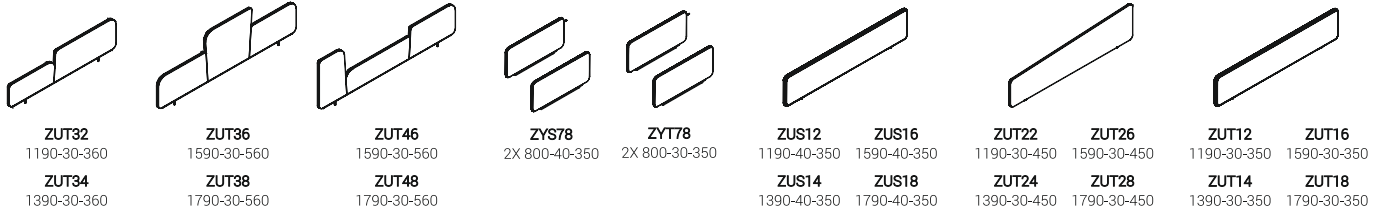

Images in the catalogue may show products slightly differently from the original version. Colours of shown materials may differ from the real ones.

The producer reserves a right to introduce changes of colours and patterns of the presented products.

The manufacturer reserves the right to introduce alterations to the products and their marking without changing the general design.

The present catalogue does not constitute a legally binding offer and is published solely for information purposes. Order may be placed only on the basis of the current price lists, available at authorised distributors.

.mdd
www.mdd.pl info@mdd.eu